

| AIR BRAKES & INDUSTRIAL  
CATALOGUE

2018

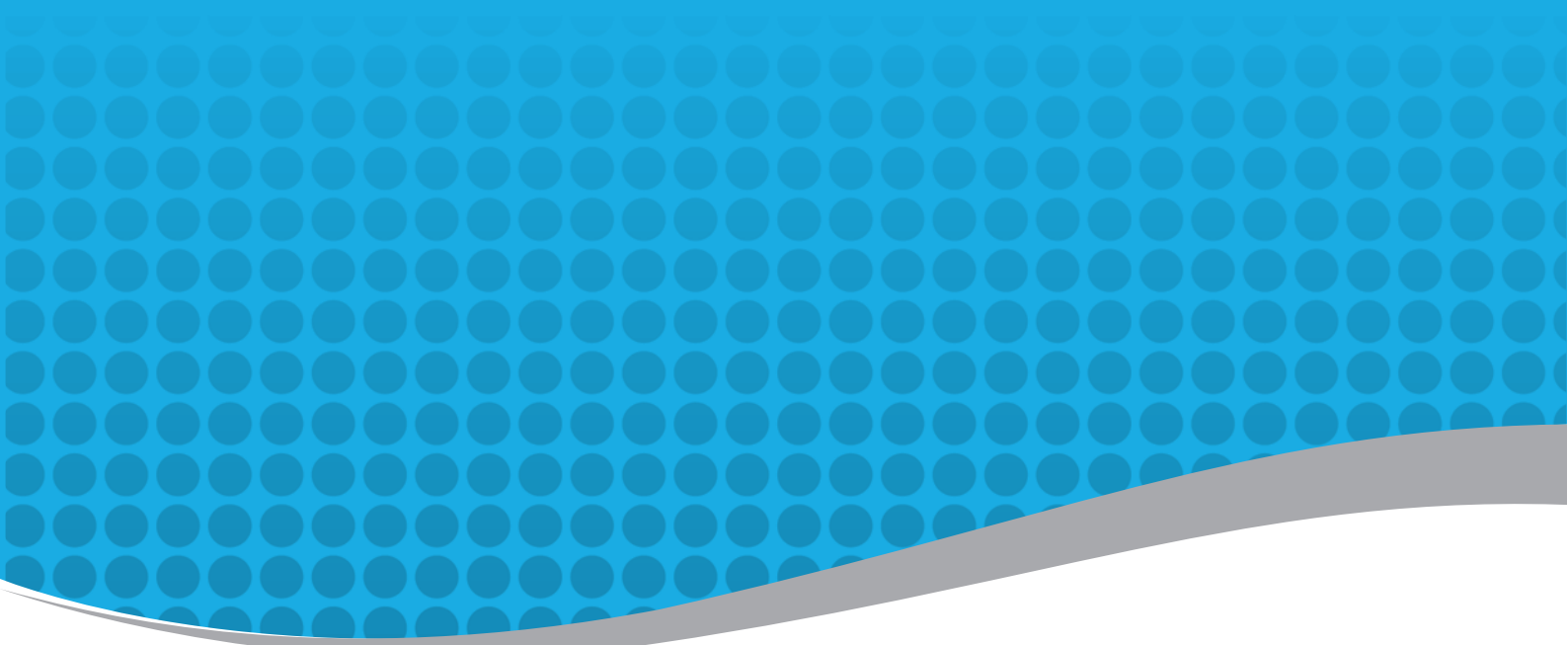



## AIRBRAKE & INDUSTRIAL



<b>Parts Listing</b>	5
• ABS Valves & Cables	6
• Air Dryers & Filters	7
• Air Horn Equipment	9
• Air Reservoirs	9
• Air Suspension	10
• Air Wipers	11
• Brake Booster	12
• Check Valves	13
• Clamps, Washers, O-Rings & Tubing	14
• Clutch	17
• Compressors & Repair Kits	18
• Couplings	22
• Drain Valves	25
• Electrical Couplers & Suzie Coil	26
• Fittings	27
• Foot Valves	36
• Gauges	38
• Gearbox Valves	38
• Grease Nipples	39
• Hand Control Valves	40

**TERMS & CONDITIONS:** The information contained in this catalogue has been designed to make parts identification easy. Reference to brands, trademarks or manufacturers part numbers is for reference and identification purposes only. Every effort has been made to ensure that all information supplied in this catalogue is correct and complete at time of printing. To the extent permissible in terms of the Consumer Protection Act No.68 of 2008, Torre Automotive (Pty) Ltd will not be responsible for any errors, omissions or exemptions however caused. The information contained in this catalogue supersedes all information in prior catalogues, and may not be reproduced without the prior written consent of Torre Automotive (Pty) Ltd.

## AIRBRAKE & INDUSTRIAL (CONT...)

	<b>Parts Listing (Cont...)</b>	
	• Hydraulic Brake Master Cylinder	44
	• Hydraulic Clutch	45
	• Hydraulic Wheel Cylinder	48
	• Load Sensing Valves	49
	• Pressure Switches	50
	• Protection Valves	51
	• Quick Release Valves	53
	• Regulators	54
	• Relay Valves	54
	• Safety Valves	57
	• Slack Adjusters	57
	• Solenoid Valves	58
	• Spring Brakes	58
	• Trailer Control Valves	61
	• Unloader Valves	61
	• Williams Controls	62
	<b>Technical Information</b>	
	• ABS Air Brake System Schematic	63
<b>TERMS &amp; CONDITIONS</b>		
	Warranty Policy	64
	Brands of TAS Automotive	65

# HOW TO USE THE CATALOGUE

## ABS VALVES & CABLES ← Section

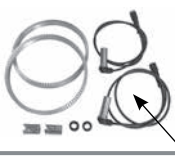
ABS Exciter Kit	
Part no:	MAG3630/EX
	<b>Includes:</b>
	Exciter rings
	Sensor cables
	Bushes

← Part description  
 ← Part number  
 ← Additional information for product use  
 ← Product image

## COMPRESSORS & REPAIR KITS ← Section

Compressor	
Part no:	MC1001
	General use, low rpm
	74mm Bore
	Single cylinder
	Air Cooled
	Self Lubrication
	<b>Repair Kit</b>
	Ring kit: MC1001A
	Repair kit: MC1001B
	Conrod: MC1001C
Bearing: MC1001D	

← Part description  
 ← Part number  
 ← Additional information for product use  
 ← Repair kit included  
 ← Product image

**MAGBRAKES** is widely acclaimed for supplying quality airbrake parts and hydraulic cylinders to the heavy-duty airbrake industry in South Africa.

**MAGBRAKES** is not only recognised for its extensive range of airbrake, brass and steel fittings, adaptors, foot valves, actuators and comprehensive variety of grease nipples, but also for the design and installation of ABS, EBS and hydraulic brake kits for trucks and trailers, all done to SABS specification.





## PARTS LISTING – AIRBRAKE & INDUSTRIAL

TAS Automotive has supplied quality airbrake and industrial products to the South African market for over 40 years. This is done in conjunction with MAGbrakes, an established and respected brand in the heavy commercial vehicle market.

MAGbrakes is widely acclaimed for supplying quality airbrake parts and hydraulic cylinders to the heavy-duty airbrake industry in South Africa. MAGbrakes is not only recognised for its extensive range of airbrake, brass and steel fittings, adaptors, foot valves, actuators and comprehensive variety of grease nipples, but also for the design and installation of ABS, EBS and hydraulic brake kits for trucks and trailers, all done to SABS specification.

Airbrake & Industrial parts are grouped in accordance to product types and then sorted in alpha numerical order for ease of identification. Please note that any reference to manufacturers is for reference and identification purposes only.





## ABS VALVES & CABLES

ABS Exciter Kit	
Part no:	MAG3630/EX
	<b>Includes:</b>
	Exciter rings
	Sensor cables
	Bushes

ABS Coupler	
Part no:	TC15P-EBS
	15 Pin male plug
	ISO12098

ABS Coupler	
Part no:	TC15S-EBS
	15 Pin female socket
	ISO12098

ABS Coupler	
Part no:	TC7P-EBS
	7 Pin male plug
	ISO7638

ABS Coupler	
Part no:	TC7S-EBS
	7 Pin female socket
	ISO7638

ABS/EBS Suzie	
Part no:	1381
	7 Pin male to male
	ISO7638

ABS/EBS Suzie	
Part no:	1381
	15 Pin male to male
	ISO12098

ABS/EBS Suzie	
Part no:	1383
	15 Pin male to male
	ISO12098

ABS/EBS Suzie	
Part no:	1384
	Metal plugs
	7 Core 3.5m
	1 x 12V, 1 x 24V

ABS Exciter Ring	
Part no:	018500309
	100 Tooth

ABS Exciter Ring	
Part no:	059510409
	Sensor and cable

Sensor Bush	
Part no:	059512309
	Sensor Bush



Sensor Bush	
Part no:	400-500-081-0
	Wabco
	2S/2m, 4S/2m, 4S/3m
	Mixed power supply

ABS Cable	
Part no:	449-133-120-0
	Wabco
	12m Extension
	Male to female

ABS Cable	
Part no:	449-384-333-0
	Wabco
	6m Supply cable

ABS Cable	
Part no:	449-712-038-0
	Wabco
	3.8m Extension cable
	With sensor

## AIR DRYERS & FILTERS

Compressor Filter	
Part no:	AG144
	Standard clamp
	Clamp size 1-1/4"

Line Filter Pneumatic	
Part no:	F8
	Workshop wall mount
	Glass inspection bowl
	Port size 1/2" NPT

Line Filter Pneumatic	
Part no:	FR4
	Workshop wall mount
	Glass inspection bowl
	With regulator and gauge
	Port size 1/4" NPT

Line Filter Pneumatic	
Part no:	FR8
	Workshop wall mount
	Glass inspection bowl
	With regulator and gauge
	Port size 1/2" NPT

Air Dryer Unit	
Part no:	KN33010
	Midland
	24V with heater
	1/8" Governor port
	Repair kit RN60A

Air Dryer Cartridge	
Part no:	MAC1000
	Universal screw on
	432-410-222-7
	Valves MV2029/MV2030







## AIR DRYERS & FILTERS (CONT...)

Air Dryer Cartridge	
Part no:	MAC1001
	Bendix type
	American vehicles
	AD2

Air Dryer Unit	
Part no:	MAC1002
	Bendix type
	American vehicles
	AD9

Air Dryer Unit	
Part no:	MAC1003
	Scania
	432-410-927-2
	Nut on top

Air Dryer Unit	
Part no:	MV2029
	With unloader combination
	432-410-000-0
	MAC1000 cartridge
	Port size M22-M16

Air Dryer Unit	
Part no:	MV2030
	Without unloader
	432-410-083-0
	MAC1000 cartridge
	Port size M22-M16

Air Dryer Unit	
Part no:	MV2063
	Nissan UD, Hino, Mitsubishi
	DR5

Air Dryer Unit	
Part no:	MV2076
	Mercedes-Benz Actros
	932-500-007-0
	Protection valve/dryer combination

Air Dryer Repair Kit	
Part no:	MV2081
	Purge valve repair
	AD9

Compressor Filter	
Part no:	RD50-4500
	MC1001 compressor
	Port size M22 male



## AIR HORN EQUIPMENT:

### AIR HORNS

Air Horn Single	
Part no:	2.010
	Frequency 340Hz
	124 DB level
	Length 390mm

Air Horn Double	
Part no:	2.160
	Frequency 335/425Hz
	122 DB level
	Length 440mm

Air Horn Single	
Part no:	2.400
	Frequency 135Hz
	121 DB level
	Length 880mm

## AIR HORN EQUIPMENT:

### HORN CONTROL VALVES

Pedal Valve Button	
Part no:	3.128
	Floor mount
	6mm Pipe connections
	Include inserts

Hand Valve	
Part no:	3.129
	Cab roof mount
	6mm Pipe connections
	Include inserts

## AIR RESERVOIRS

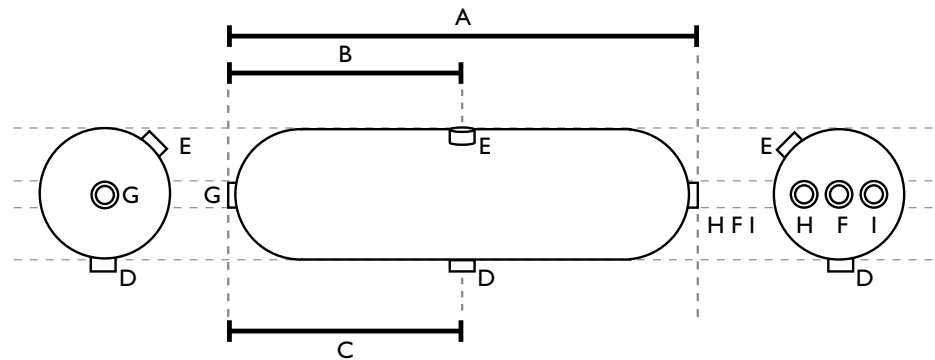



Volume			Dimensions			Ports						Bracket
Part No.	Litre	Diameter	A	B	C	D	E	F	G	H	I	
AGA179	5	206mm	195mm									
MAG10	10	206mm	384mm	192mm	192mm	X	X	X	X			BA17
MAG20	20	206mm	692mm	346mm	346mm	X	X	X	X			BA17
MAG20-H	20	276mm	530mm		265mm	X			X	X	X	BA18
MAG30	30	276mm	580mm		290mm	X			X	X	X	BA18
MAG40	40	276mm	740mm		373mm	X			X	X	X	BA18
MAG60	60	276mm	1090mm		550mm	X			X	X	X	BA18



## AIR SUSPENSION

### AUXILIARY VALVES

Valve Brake	
Part no:	AE1141
	Knorr Bremse
	Automatic axle lift
	Port size M16

Valve Brake	
Part no:	MV2055
	Manual raise lower
	Port size M14

Valve Brake	
Part no:	463-084-020-0
	Wabco
	Automatic axle lift
	Port size M16

## AIR SUSPENSION

### LEVELLING VALVES

Valve Brake	
Part no:	MV2056
	Medium/slow flow with rod 13bar
	Port size M12
	Nominal diameter 3mm
	Flow rate 260L/min

Valve Brake	
Part no:	MV2057
	Medium/slow flow with rod 12.5bar
	Port size M12
	Nominal diameter 3mm
	Flow rate 260L/min

Valve Brake	
Part no:	464-006-002-0
	Medium/high flow with rod
	Port size M12
	Nominal diameter 3mm
	Flow rate 360L/min

Valve Brake	
Part no:	612-017-061
	Medium/slow flow with rod
	Port size M12
	Nominal diameter 1.25mm
	Flow rate 260L/min

Valve Brake	
Part no:	612-025-001
	Lower axle linkage

Valve Brake	
Part no:	612-035-051
	Medium/high flow with rod
	Port size M8 push in
	Nominal diameter 3mm
	Flow rate 400L/min



## AIR WIPER

### ARMS

Wiper Arm Single	
Part no:	C1503-18
	Length 457mm
	18" Blade
	Arm pivot to blade connection

Wiper Arm Single	
Part no:	C1503-20
	Length 508mm
	20" Blade
	Arm pivot to blade connection

## AIR WIPER

### BLADES

Wiper Blade	
Part no:	C1100-18
	Single flat blade
	18" Blade
	Length 457mm

Wiper Blade	
Part no:	C1100-20
	Single flat blade
	20" Blade
	Length 508mm

Wiper Blade	
Part no:	C1100-22
	Single flat blade
	22" Blade
	Length 558mm

## AIR WIPER

### CONTROLS

Wiper Control	
Part no:	GC61
	No park feature
	Returns to rest position
	New motor
	Port size 1/8"

Wiper Control	
Part no:	K110-3
	With park feature
	Returns to rest position
	Old motor
	Port size 1/8"

Wiper Control	
Part no:	K110-7
	With park feature
	Returns to rest position
	New motor
	Port Size 1/8"

## AIR WIPER

### MOTORS

Wiper Motor	
Part no:	M582-1-90
	Port size 3/8"
	90° Sweep angle

Wiper Motor	
Part no:	M582-1-105
	Port size 1/4"
	105° Sweep angle



## AIR WIPER

### SHAFT ASSEMBLIES

Wiper Shaft	
Part no:	F876-4
	4"
	Length 203mm
	With nuts and washers

Wiper Shaft	
Part no:	F876-5
	5"
	Length 229mm
	With nuts and washers

## BRAKE BOOSTER

### PISTON TYPE

Booster Piston	
Part no:	340-005-001
	Force @ 600kPa @ 1/3 stroke
	Force 4200N
	Port size M22
	Clevis diameter 100mm

Booster Piston	
Part no:	340-008-001
	Force @ 600kPa @ 1/3 stroke
	Force 6700N
	Port size M22
	Clevis diameter 125mm

Booster Piston	
Part no:	340-013-001
	Force @ 600kPa @ 1/3 stroke
	Force 9700N
	Port size M22
	Clevis diameter 150mm

Booster Piston	
Part no:	340-034-201
	Force @ 680kPa @ 1/3 stroke
	Force 4050N
	Port size M16
	Clevis diameter 90mm
	1.75" x 12 UNS

## BRAKE BOOSTER

### SINGLE DIAPHRAGM

Booster Single Diaphragm	
Part no:	9-3000
	Type 9
	Port size 3/8" BSP
	Clevis pin diameter 12.7mm
	Stroke length 45mm

Booster Single Diaphragm	
Part no:	12-3000
	Type 12
	Port size 3/8" BSP
	Clevis pin diameter 12.7mm
	Stroke length 45mm

Booster Single Diaphragm	
Part no:	16-3000
	Type 16
	Port size 3/8" BSP
	Clevis pin diameter 12.7mm
	Stroke length 57mm

Booster Single Diaphragm	
Part no:	20-3000
	Type 20
	Port size 3/8" BSP
	Clevis pin diameter 12.7mm
	Stroke length 57mm



Booster Single Diaphragm	
Part no:	24-3000
	Type 24
	Port size 3/8" BSP
	Clevis pin diameter 12.7mm
	Stroke length 57mm

Booster Single Diaphragm	
Part no:	30-3000
	Type 30
	Port size 3/8" BSP
	Clevis pin diameter 12.7mm
	Stroke length 64mm

Booster Single Diaphragm	
Part no:	36-3000
	Type 36
	Port size 3/8" BSP
	Clevis pin diameter 12.7mm
	Stroke length 76mm

## BRAKE BOOSTER

### VACUUM TYPE

Booster Vacuum Pull	
Part no:	OB651
	Port size 1/4" BSP
	Pull force 1.3KN
	Max stroke 90mm
	Work stroke 45mm
	Mounting M12 bolt 75mm centres
	Diaphragm BM 21037

## CHECK VALVES

### DOUBLE

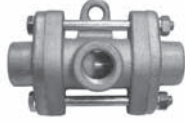
Double Check Valve	
Part no:	KN25060
	Inlet 3/8" female
	Outlet 3/8" female

Double Check Valve	
Part no:	7200
	Sealco
	Extra 1/4" port
	Inlet 1/2" female
	Outlet 1/2" female

Double Check Valve	
Part no:	333-001-001
	Inlet M22 female
	Outlet M22 female

Double Check Valve	
Part no:	434-208-029-0
	Wabco
	Inlet M22 female
	Outlet M22 female





## CHECK VALVES

### SINGLE

Single Check Valve	
Part no:	KN23000
	Midland type
	Inlet 1/2" female
	Outlet 1/2" male

Single Check Valve	
Part no:	KN23010
	Midland type
	Inlet 3/8" female
	Outlet 3/8" male

Single Check Valve	
Part no:	KN23040
	Midland type
	Inlet 3/4" female
	Outlet 3/4" male

Single Check Valve	
Part no:	PV105
	Vacuum
	Inlet 1/2" female
	Outlet 1/2" female

Single Check Valve	
Part no:	2200-1/2
	Sealco
	Inlet 1/2" female
	Outlet 1/2" female

Single Check Valve	
Part no:	2200-3/4
	Sealco
	Inlet 3/4" female
	Outlet 3/4" female

Single Check Valve	
Part no:	314-001-001
	Inlet M22 female
	Outlet M22 female

Single Check Valve	
Part no:	44510-1090
	Toyota Hino
	Inlet 3/8" female
	Outlet 3/8" female

## CLAMPS, WASHERS, O-RINGS & TUBING

P Clamp	
Part no:	AC18852
	Rubber Coated
	Pipe OD 8mm

P Clamp	
Part no:	AC18853
	Rubber Coated
	Pipe OD 10mm

P Clamp	
Part no:	AC18854
	Rubber Coated
	Pipe OD 12mm





Aluminium Washer	
Part no:	AW1216
	M12
	12.20 x 15.40 x 1.5

Aluminium Washer	
Part no:	AW1418
	M14
	14.20 x 19.90 x 1.5

Aluminium Washer	
Part no:	AW1620
	M16
	16.20 x 21.90 x 1.5

Aluminium Washer	
Part no:	AW1822
	M18
	18.20 x 21.90 x 1.5

Aluminium Washer	
Part no:	AW2227
	M22
	22.20 x 26.90 x 1.5

Aluminium Washer	
Part no:	AW2632
	M26
	26 x 32 x 1.5

Hose Clamp	
Part no:	C0
	Rubber Hose
	Suits 3/8" hose

Hose Clamp	
Part no:	C1
	Rubber Hose
	Suits 1/2" hose

O-Ring kit	
Part no:	ORK-IP400
	Imperial assortment
	400 O-rings

O-Ring kit	
Part no:	ORK-M400
	Metric assortment
	400 O-rings

P Clamp	
Part no:	PC1
	Single non coated
	Pipe OD 6mm

P Clamp	
Part no:	PC4
	Single non coated
	Pipe OD 12mm





## CLAMPS, WASHERS, O-RINGS & TUBING (CONT...)

O-Ring	
Part no:	2097603
	M16
	17.70 x 13.30 x 2.40

Thrust Washer	
Part no:	2695603
	M16
	No O-ring

O-Ring	
Part no:	2097605
	M22
	24.10 x 19.30 x 2.40

Thrust Washer	
Part no:	2695605
	M22
	No O-ring

Bundy Tube Metric & Imperial (6m length)					
Part No:	BTB-4,76	BTB-6	BTB-8	BTB-10	BTB-12
Outer Dimension	3/16"	6mm	8mm	10mm	12mm

Nylon Tube Black Imperial (30m Rolls)					
Part No:	BTN-1/8	BTN-3/16	BTN-1/4	BTN-3/8	BTN-1/2
Outer Dimension	1/8"	3/16"	1/4"	3/8"	1/2"

Nylon Tube Black Metric (30m Rolls)						
Part No:	BTN-3	BTN-4	BTN-5	BTN-6	BTN-8	BTN-9
Outer Dimension	3mm	4mm	5mm	6mm	8mm	9mm
Part No:	BTN-10	BTN-11	BTN-12	BTN-14	BTN-15	BTN-16
Outer Dimension	10mm	11mm	12mm	14mm	15mm	16mm

Nylon Tube Colour Metric (30m Rolls)					
Part No:	BTN-6B	BTN-6R	BTN-8B	BTN-12R	BTN-12Y
Outer Dimension	6mm Blue	6mm Red	8mm Blue	12mm Red	12mm Yellow

Rubber Hose Imperial		
Part No:	BHP-3/8	BHP-1/2
Inner Dimension	3/8"	1/2"

Steel Tube Metric (6m length)						
Part No.	BTS-6	BTS-8	BTS-10	BTS-12	BTS-15	BTS-18
Outer Dimension	6mm	8mm	10mm	12MM	15mm	18mm





## CLUTCH

### AIRMASTERS

Airmaster	
Part no:	MV2044
	MC815305
	Short
	Mitsubishi Fuso
	YBB-A105

Airmaster	
Part no:	MV2045
	20307040
	Long
	Isuzu

Airmaster	
Part no:	MV2046
	MC828264
	Short
	Mitsubishi Fuso
	YBB-A103

Airmaster	
Part no:	MV2090
	MC815402
	Long
	Nissan, Isuzu, Mitsubishi
	YBB-A106

Airmaster	
Part no:	MV2091
	20307150
	Short
	Isuzu

Airmaster	
Part no:	MV2092
	MC828265
	Long
	Mitsubishi
	YBB-A104

## CLUTCH

### BOOSTERS

Clutch Booster	
Part no:	MV2028
	Mercedes-Benz
	970-051-131-0
	Diameter 85mm
	Port M16-M14

Clutch Booster	
Part no:	MV2047
	Hino/Nissan
	Diameter 75mm
	VG3204

Clutch Booster	
Part no:	MV2052
	MAN F80/85
	Diameter 90mm
	VG3156

Clutch Booster	
Part no:	MV2058
	Mercedes-Benz
	970-051-176-0
	Diameter 108mm
	Stroke 85mm

Clutch Booster	
Part no:	MV2059
	Mercedes-Benz Actros
	970-051-431-0
	Diameter 108mm
	Stroke 85mm

Clutch Booster	
Part no:	MV2060
	Mercedes-Benz
	970-051-159-0
	Diameter 108mm
	Stroke 75mm



## CLUTCH

### BOOSTERS (CONT...)

Clutch Booster	
Part no:	642-01608
	Japanese, Hino, Nissan, Isuzu, Mitsubishi
	Diameter 70mm
	Port M14
	Port M12

Clutch Booster	
Part no:	642-03502
	Japanese, Hino, Nissan, Isuzu, Mitsubishi
	Diameter 90mm
	Port M14
	Port M12

## COMPRESSORS & REPAIR KITS

Compressor	
Part no:	MC1001
	General use, low rpm
	74mm Bore
	Single cylinder
	Air Cooled
	Self Lubrication
	<b>Repair Kit</b>
	Ring kit: MC1001A
	Repair kit: MC1001B
	Conrod: MC1001C
	Bearing: MC1001D

Compressor	
Part no:	MC1001MOD
	General use, with pulley, low rpm
	74mm Bore
	Single cylinder
	Air cooled
	Self lubrication
	<b>Repair Kit</b>
	Ring kit: MC1001A
	Repair kit: MC1001B
	Conrod: MC1001C
	Bearing: MC1001D

Compressor	
Part no:	MC1002
	Belt drive
	60mm Bore
	Single cylinder
	Air cooled
	Engine lubrication
	<b>Repair Kit</b>
	Ring kit: MC1002D
	Repair kit: MC1002A
	Conrod: MC1002F
	Bearing: MC1002E
Head kit: MC1002B	
Piston: MC1002C	

Compressor	
Part no:	MC1003
	General use 3400rpm
	75mm Bore
	Single cylinder
	Air cooled
	Self lubrication
	<b>Repair Kit</b>
	Ring kit: MC1003A
	Repair kit: MC1003B
	Conrod: MC1003C
	Bearing: MC1003D





Compressor	
Part no:	MC1004
	Mercedes-Benz Axor OM457
	88mm Bore
	Single cylinder
	Water cooled
	Engine lubrication
	<b>Repair Kit</b>
	Ring kit: MC1004A
	Repair kit: MC1004B
	Conrod: MC1004D
	Head kit: MC1004C

Compressor	
Part no:	MC1007
	MAN F2000
	90mm Bore
	Twin cylinder
	Water cooled
	Engine lubrication
	<b>Repair Kit</b>
	Ring kit: MC1007A
	Repair kit: MC1007B
	Conrod: MC1007C

Compressor	
Part no:	MC1005
	Mercedes-Benz OM355/360A
	88mm Bore
	Single cylinder
	Air cooled
	Engine lubrication
	<b>Repair Kit</b>
	Ring kit: MC1005A
	Repair kit: MC1005B
	Conrod: MC1005C
	Bearing: MC1005D

Compressor	
Part no:	MC1008
	Iveco Series 170/190/220 /240
	80mm Bore
	Twin cylinder
	Water cooled
	Engine lubrication
	<b>Repair Kit</b>
	Ring kit: MC1008A
	Repair kit: MC1008B
	Conrod: MC1008C

Compressor	
Part no:	MC1006
	Mercedes/MAN OM407/442
	90mm Bore
	Single cylinder
	Water cooled
	Engine lubrication
	<b>Repair Kit</b>
	Ring kit: MC1006A
	Repair kit: MC1006B
	Conrod: MC1006C

Compressor	
Part no:	MC1009
	Iveco Eurotech 180/440
	82mm Bore
	Twin cylinder
	Water cooled
	Engine lubrication
	<b>Repair Kit</b>
	Ring kit MC1009A
	Repair kit MC1009B
	Conrod MC1009C
	Bearing MC1009D





## COMPRESSORS & REPAIR KITS (CONT...)

Clutch Booster	
Part no:	MC1010
	Scania 113/143 non ESS
	75mm Bore
	Twin cylinder
	Water cooled
	Engine lubrication
	<b>Repair Kit</b>
	Ring kit: MC1010A
	Repair kit: MC1010B
	Conrod: MC1010C
	Bearing: MC1010D

Compressor	
Part no:	MC1013
	Volvo B6B/B10R/FM12 with ESS
	88mm Bore
	Twin cylinder
	Water cooled
	Engine lubrication
	<b>Repair Kit</b>
	Ring kit: MC1013A
	Repair kit: MC1012B
	Conrod: MC1012C
	Bearing: MC1012D

Compressor	
Part no:	MC1011
	Volvo B7L
	88mm Bore
	Twin cylinder
	Water cooled
	Engine lubrication
	<b>Repair Kit</b>
	Ring kit: MC1011A
	Repair kit: MC1011B
	Conrod: MC1011C
	Bearing: MC1011D

Compressor	
Part no:	MC1014
	Volvo B7R
	88mm Bore
	Twin cylinder
	Water cooled
	Engine lubrication
	<b>Repair Kit</b>
	Ring kit: MC1014A
	Repair kit: MC1014B
	Conrod: MC1014C

Compressor	
Part no:	MC1012
	Volvo FH12/FH16 with ESS
	88mm Bore
	Twin cylinder
	Water cooled
	Engine lubrication
	<b>Repair Kit</b>
	Ring kit: MC1012A
	Repair kit: MC1012B
	Conrod: MC1012C
	Bearing: MC1012D

Compressor	
Part no:	MC1015
	Mercedes-Benz/ MAN OM402/403/407
	90mm Bore
	Single cylinder
	Air cooled
	Engine lubrication
	<b>Repair Kit</b>
	Ring kit: MC1006A
	Repair kit: MC1006B
	Conrod: MC1006C





Compressor	
Part no:	MC1016
	Mercedes-Benz/MAN OM402/403/407
	90mm Bore
	Single cylinder
	Water cooled
	Engine lubrication
	<b>Repair Kit</b>
	Ring kit: MC1006A
	Repair kit: MC1006B
	Conrod: MC1006C

Compressor	
Part no:	MC1019
	Mercedes-Benz OM355
	90mm Bore
	Single cylinder
	Air cooled
	Engine lubrication
	<b>Repair Kit</b>
	Ring kit: MC1019A
	Repair kit: MC1019B
	Conrod: MC1019C

Compressor	
Part no:	MC1017
	Mercedes-Benz Atego
	85mm Bore
	Single cylinder
	Water cooled
	Engine lubrication
	<b>Repair Kit</b>
	Ring kit: MC1017A
	Repair kit: MC1017B
	Conrod: MC1017C

Compressor	
Part no:	MC1020
	Deutz
	75mm Bore
	Single cylinder
	Air cooled
	Engine lubrication
	<b>Repair Kit</b>
	Ring kit: MC1020A
	Repair kit: MC1020B
	Conrod: MC1020C
	Bearing: MC1020D

Compressor	
Part no:	MC1018
	Mercedes-Benz OM366LA
	75mm Bore
	Single cylinder
	Air cooled
	Engine lubrication
	<b>Repair Kit</b>
	Ring kit: MC1018A
	Repair kit: MC1018B
	Conrod: MC1018C
	Bearing: MC1018D

Compressor	
Part no:	MC1021
	Mercedes-Benz OM366
	88mm Bore
	Single cylinder
	Air cooled
	Engine lubrication
	<b>Repair Kit</b>
	Ring kit: MC1021A
	Repair kit: MC1021B
	Conrod: MC1021C



## COMPRESSORS & REPAIR KITS (CONT...)

Clutch Booster	
Part no:	MC1022
	Deutz F8L413F
	88mm Bore
	Single cylinder
	Air cooled
	Engine lubrication
	<b>Repair Kit</b>
	Ring kit: MC1022A
Repair kit: MC1022B	
Conrod: MC1022C	

Vacuum Exhauster	
Part no:	5-10402
	Diaphragm vacuum pump
	Running speed 3000-4000 RPM
	Maximum speed 4500 RPM
	Oil type SAE24/40

## COUPLINGS

### AIR LINE COUPLERS

Air Chuck	
Part no:	AF30
	Thread female 1/8"

Coupler	
Part no:	AF4000
	Thread female 1/4"

Coupler	
Part no:	AF4001B
	Thread male 1/4"

Connector	
Part no:	AF4002
	Thread male 1/8"

Connector	
Part no:	AF4004
	Thread male 1/4"

Connector	
Part no:	AF4024
	Hose ID 1/4"

Connector	
Part no:	AF4025
	Hose ID 5/16"

Connector	
Part no:	AF4026
	Hose ID 3/8"



Connector	
Part no:	AF40014
	Thread female 1/4"

Drain Cock	
Part no:	201-4
	Thread male 1/4"

Blow Gun	
Part no:	4785
	Thread female 1/8"

Drain Cock	
Part no:	204-2
	Thread male 1/8"

## COUPLINGS: DRAIN COCKS & VALVES

Drain Cock	
Part no:	204-4
	Thread male 1/4"

Valve Shut-off	
Part no:	BV-8
	Thread female 1/2"
	Ball type

Valve Shut-off	
Part no:	295-4
	Thread female 1/4"
	Pipe 3 way

Valve Shut-off	
Part no:	BV-12
	Thread female 3/4"
	Ball type

Valve Shut-off	
Part no:	363-4
	Thread female 1/4"

Drain Cock	
Part no:	201-2
	Thread male 1/8"

Valve Needle	
Part no:	462-4
	Tube OD 1/4"







## COUPLINGS:

### F&J COUPLINGS

Coupling	
Part no:	BA6
	Female Thread 1/2" female

Coupling	
Part no:	BA6C
	Female Operating plug complete Thread 1/2" female

Coupling	
Part no:	BA7
	Short stem shut-off valve Female coupling Thread 1/2" female

Coupling	
Part no:	BA8
	Long stem shut-off valve Male coupling Thread 1/2" female

Coupling	
Part no:	BA10
	Bracket

Coupling	
Part no:	BA12
	Dust flap

Coupling	
Part no:	BA13
	Complete female coupling Emergency with shut-off valve Thread 1/2" female

Coupling	
Part no:	BA14
	Complete male coupling Service with shut-off valve Thread 1/2" female

Coupling	
Part no:	BD1
	Male Thread 1/2" female

Coupling	
Part no:	BD8
	Operating plug Thread 1/2" female

Coupling	
Part no:	CF1-15
	Dummy with chain Male coupling

Coupling	
Part no:	CM1-07
	Dummy with chain Female coupling

Coupling	
Part no:	CW1-1
	F&J Washer





## COUPLINGS

### PALM COUPLINGS

Coupling	
Part no:	10405
	Palm coupling seal

Coupling	
Part no:	11401
	Dummy with chain
	Palm coupling

Coupling	
Part no:	334-054-201
	Trailer service
	No shut-off valve
	Port size M16

Coupling	
Part no:	334-055-201
	Trailer emergency
	No shut-off valve
	Port size M16

Coupling	
Part no:	334-055-211
	Trailer emergency
	No shut-off valve
	Port size M22

Coupling	
Part no:	334-063-001
	Truck emergency
	With shut-off valve
	Port size M16

Coupling	
Part no:	334-064-001
	Truck service
	With shut-off valve
	Port size M16

Coupling	
Part no:	334-071-001
	Truck emergency
	With shut-off valve
	Port size M22

Coupling	
Part no:	334-072-001
	Truck service
	With shut-off valve
	Port size M22

## DRAIN VALVES

Drain Valve	
Part no:	315-016-001
	Grau
	Automatic
	Port size M22 male

Drain Valve	
Part no:	315-019-001
	Standard
	Manual ring pull
	Port size M22 male

Drain Valve	
Part no:	KN24000
	Midland
	Automatic
	With ring pull and cable
	Port size 3/8 NPT



## ELECTRICAL COUPLERS & SUZIE COILS

Junction Box	
Part no:	BE4
	Henred Fruehauf
	Black plastic 8 way
	Screw connection

Trailer Plug	
Part no:	TC7P
	7 Pin standard
	4 Pins 3 holes

Trailer Socket	
Part no:	TC7S
	7 Pin standard
	4 Holes 3 pins

Junction Box	
Part no:	TL3540-00
	8 Way screw connection
	See through plastic cover

Electrical Suzie	
Part no:	1372
	7 Core 1.25mm

Electrical Suzie	
Part no:	1373
	7 Core 1.60mm

Suzie Coil	
Part no:	1375
	Yellow service
	Thread 1/2" BSP

Suzie Coil	
Part no:	1376
	Red emergency
	Thread 1/2" BSP

Electrical Suzie	
Part no:	1379
	Green Mamba
	7 Core
	Without plugs

Electrical Suzie	
Part no:	1380
	Green Mamba
	7 Core
	With plugs

Suzie Coil	
Part no:	1375-VOLVO
	Yellow service
	Volvo specification
	Thread M16

Suzie Coil	
Part no:	1376-VOLVO
	Red emergency
	Volvo specification
	Thread M16



## FITTINGS

### BRASS AIR BRAKE

Ferrule		
	Part no:	Tube OD
	60N-10M	10mm
	60N-12M	12mm
	60N-3	3/16"
	60N-4	1/4"
	60N-5	5/16"
	60N-6	3/8"
	60N-6M	6mm
	60N-8	1/2"

Long Nut		
	Part no:	Tube OD
	61AB-4	1/4"
	61AB-5	5/16"
	61AB-6	3/8"
	61AB-6M	6mm
	61AB-8	1/2"

Union		
	Part no:	Tube OD
	62AB-12M	12mm
	62AB-3	3/16"
	62AB-4	1/4"
	62AB-5	5/16"
	62AB-6	3/8"
	62AB-6M	6mm
	62AB-8	1/2"

Insert		
	Part no:	Tube OD
	63-3	3/16"
	63-4	1/4"
	63-5	5/16"
	63-6	3/8"
	63-8	1/2"

Union Tee		
	Part no:	Tube OD
	64AB-12M	12mm
	64AB-4	1/4"
	64AB-5	5/16"
	64AB-6	3/8"
	64AB-8	1/2"

Union Elbow		
	Part no:	Tube OD
	65AB-10M	10mm
	65AB-12M	12mm
	65AB-8	1/2"

Male Connector			
	Part no:	Tube OD	Thread
	68AB-12M16	12mm	M16
	68AB-12M2	12mm	1/8"
	68AB-12M22	12mm	M22
	68AB-12M4	12mm	1/4"
	68AB-12M6	12mm	3/8"
	68AB-12M8	12mm	1/2"
	68AB-12M8P	12mm	1/2" BSP
	68AB-3	3/16"	1/8"
	68AB-4	1/4"	1/8"
	68AB-4A	1/4"	1/4"
	68AB-5	5/16"	1/8"
	68AB-5A	5/16"	1/4"
	68AB-6	3/8"	1/4"
	68AB-6B	3/8"	3/8"
	68AB-6M2	6mm	1/8"
	68AB-6M4	6mm	1/4"
	68AB-8	1/2"	3/8"
	68AB-8A	1/2"	1/2"
	68AB-8B	1/2"	1/4"





## FITTINGS

### BRASS AIR BRAKE (CONT...)

Male Elbow			
	Part no:	Tube OD	Thread
	69AB-12M2	12mm	1/8"
	69AB-12M4	12mm	1/4"
	69AB-12M6	12mm	3/8"
	69AB-12M8	12mm	1/2"
	69AB-4	1/4"	1/8"
	69AB-4A	1/4"	1/4"
	69AB-6	3/8"	1/4"
	69AB-6B	3/8"	3/8"
	69AB-6M4	6mm	1/4"
	69AB-8	1/2"	3/8"
	69AB-8A	1/2"	1/2"
	69AB-8C	1/2"	1/8"

Male Run Tee			
	Part no:	Tube OD	Thread
	71AB-12M6	12mm	3/8"
	71AB-8	1/2"	1/2"

Male Branch Tee			
	Part no:	Tube OD	Thread
	72AB-12M6	12mm	3/8"
	72AB-8	1/2"	3/8"

Bulkhead Connector		
	Part no:	Tube OD
	74AB-12M	12mm
	74AB-8	1/2"

Bulkhead Connector			
	Part no:	Tube OD	Hose ID
	75AB-12M6	12mm	1/2"

Bulkhead Connector			
	Part no:	Tube OD	Thread
	78AB-12M22	12mm	M22
	78AB-12M8	12mm	1/2"
	78AB-12M8F	12mm	1/2" Female
	78AB-12M8P6	12mm	1/2" BSP

## FITTINGS

### BRASS COMPRESSION

Ferrule		
	Part no:	Tube OD
	60-2	1/8"
	60-3	3/16"
	60-4	1/4"
	60-5	5/16"
	60-6	3/8"
	60-8	1/2"

Pipe Nut		
	Part no:	Tube OD
	61-2	1/8"
	61-3	3/16"
	61-4	1/4"
	61-5	5/16"
	61-6	3/8"
	61-8	1/2"





Line Connector		
	Part no:	Tube OD
	62-2	1/8"
	62-3	3/16"
	62-4	1/4"
	62-5	5/16"
	62-6	3/8"
	62-8	1/2"

Union Tee		
	Part no:	Tube OD
	64-2	1/8"
	64-3	3/16"
	64-4	1/4"
	64-5	5/16"
	64-6	3/8"
	64-8	1/2"

Union Elbow		
	Part no:	Tube OD
	65-2	1/8"
	65-3	3/16"
	65-4	1/4"
	65-5	5/16"
	65-6	3/8"
	65-8	1/2"

Female Connector			
	Part no:	Tube OD	Thread
	66-2	1/8"	1/8"
	66-3	3/16"	1/8"
	66-4	1/4"	1/8"
	66-4A	1/4"	1/4"
	66-5	5/16"	1/8"
	66-5A	5/16"	1/4"
	66-6	3/4"	1/4"
	66-8	1/2"	3/8"

Male Connector			
	Part no:	Tube OD	Thread
	68-2	1/8"	1/8"
	68-3	3/16"	1/8"
	68-4	1/4"	1/8"
	68-4A	1/4"	1/4"
	68-5	5/16"	1/8"
	68-5A	5/16"	1/4"
	68-6	3/8"	1/4"
	68-6A	3/8"	1/8"
	68-6B	3/8"	3/8"
	68-6C	3/8"	1/2"
	68-8	1/2"	3/8"
	68-8A	1/2"	1/2"
	68-8C	1/2"	1/8"
68-8B	1/2"	1/4"	

Male Elbow			
	Part no:	Tube OD	Thread
	69-2	1/8"	1/8"
	69-3	3/16"	1/8"
	69-4	1/4"	1/8"
	69-4A	1/4"	1/4"
	69-5	5/16"	1/8"
	69-5A	5/16"	1/4"
	69-6	3/8"	1/4"
	69-6A	3/8"	1/8"
	69-6B	3/8"	3/8"
	69-6C	3/8"	1/2"
	69-8	1/2"	3/8"
	69-8A	1/2"	1/2"
	69-8B	1/2"	1/4"
69-8C	1/2"	1/8"	

Male Branch Tee			
	Part no:	Tube OD	Thread
	72-3	3/16"	1/8"
	72-4	1/4"	1/8"
	72-4A	1/4"	1/4"
	72-5	5/16"	1/8"
	72-5A	5/16"	1/4"
	72-6	3/8"	1/4"
	72-8	1/2"	3/8"



## FITTINGS

### BRASS COMPRESSION (CONT...)

Bulkhead Connector		
	Part no:	Tube OD
	74-4	1/4"
	74-5	5/16"
	74-6	3/8"
	74-8	1/2"

## FITTINGS

### BRASS PIPE

Stem Pipe Adaptor			
	Part no:	Hose ID	Tube OD
	AF1-808	1/2"	1/2"
	AF1-1208	1/2"	12mm

Hose Splicers		
	Part no:	Tube OD
	AF20	1/4"
	AF21	5/16"
	AF22M	3/8"

Hosebarbs			
	Part no:	Thread Male	Hose ID
	AF203	1/8"	3/16"
	AF204	1/8"	1/4"
	AF205	1/8"	5/16"
	AF206	1/8"	3/8"
	AF208	1/8"	1/2"
	AF404	1/4"	1/4"
	AF405	1/4"	5/16"
	AF406	1/4"	3/8"
	AF408	1/4"	1/2"
	AF604	3/8"	1/4"
	AF605	3/8"	5/16"
	AF606	3/8"	3/8"
	AF608	3/8"	1/2"
	AF808	1/2"	1/2"
	AF1608	M16	1/2"
	AF2208	M22	1/2"

Hose Female Swivel			
	Part no:	Thread Female	Tube OD
	AF40A	1/4"	1/4"
	AF40B	1/4"	5/16"
	AF40C	1/4"	3/8"

Hose Tee		
	Part no:	Hose ID
	TP-12	1/2"

Socket			
	Part no:	Thread	Thread
	103-2	1/8"	1/8"
	103-4	1/4"	1/4"
	103-6	3/8"	3/8"
	103-8	1/2"	1/2"
	104-42	1/4"	1/8"
	104-64	3/8"	1/4"





Hex Plug		
	Part no:	Thread
	109-2	1/8"
	109-4	1/4"
	109-6	3/8"
	109-8	1/2"
	109-22M	M22 x 1.5

Female Elbow		
	Part no:	Thread Female
	114-2	1/8"
	114-4	1/4"
	114-6	3/8"
	114-8	1/2"

Reducing Bush			
	Part no:	Thread Male	Thread Female
	110-4	1/4"	1/8"
	110-6	3/8"	1/4"
	110-6A	3/8"	1/8"
	110-8	1/2"	3/8"
	110-8A	1/2"	1/4"
	110-8B	1/2"	1/8"
	110-12	3/4"	1/2"
	110-12A	3/4"	3/8"
	110-12B	3/4"	1/4"
	110-142	M14	1/8"
	110-162	M16	1/8"
	110-164	M16	1/4"
	110-22A	M22 x 1.25	3/8"
110-22B	M22 x 1.25	1/4"	

Male Branch Tee			
	Part no:	Thread Male	Thread Female
	115-2	1/8"	1/8"
	115-4	1/4"	1/4"
	115-6	3/8"	3/8"

Female Cross Piece		
	Part no:	Thread Female
	116-4	1/4"

Female Tee		
	Part no:	Thread Female
	112-2	1/8"
	112-4	1/4"
	112-6	3/8"
	112-8	1/2"

Street Elbow			
	Part no:	Thread Male	Thread Female
	117-22	1/8"	1/8"
	117-42	1/8"	1/4"
	117-44	1/4"	1/4"
	117-66	3/8"	3/8"

Long Pipe Nipple			
	Part no:	Thread Male	Thread Female
	113-2	1/8"	1/8"
	113-4	1/4"	1/4"
	113-6	3/8"	3/8"
	113-8	1/2"	1/2"

Male Female Adaptor			
	Part no:	Tube OD	Thread
	MF1622	M16	M22
	120-2	1/8"	1/8"
	120-4	1/4"	1/4"
	120-4A	1/8"	1/4"
	120-6	3/8"	3/8"
	120-6A	1/4"	3/8"
	120-8	1/2"	1/2"
120-8A	3/8"	1/2"	







## FITTINGS

BRASS PIPE (CONT...)

Close Nipple		
	Part no:	Thread Male
	121-2	1/8"
	121-4	1/4"
	121-6	3/8"
	121-8	1/2"

Hex Nipple			
	Part no:	Thread Male	Thread Female
	122-2	1/8"	1/8"
	122-4	1/4"	1/4"
	122-4A	1/4"	1/8"
	122-6	3/8"	3/8"
	122-6A	3/8"	1/4"
	122-8	1/2"	1/2"
	122-8A	1/2"	3/8"
	122-8-22	1/2"	M22

Street Tee			
	Part no:	Thread Male	Thread Female
	127-2	1/8"	1/8"
	127-4	1/4"	1/4"
	127-6	3/8"	3/8"
	127-8	1/2"	1/2"

## FITTINGS

NYLON QUICK FIT

Union Imperial		
	Part no:	Tube OD
	P60202	1/8"
	P60203	3/16"
	P60204	1/4"
	P60206	3/8"
	P60208	1/2"

Union Metric		
	Part no:	Tube OD
	P62M4	4mm
	P62M6	6mm
	P62M8	8mm
	P62M10	10mm
	P62M12	12mm
	P62M14	14mm
	P62M15	15mm
P62M16	16mm	

Union Tee		
	Part no:	Tube OD
	P64M4	4mm
	P64M6	6mm
	P64M8	8mm
	P64M10	10mm
	P64M12	12mm

Union Elbow		
	Part no:	Tube OD
	P65M6	6mm
	P65M8	8mm
	P65M10	10mm
	P65M12	12mm



Male Connector			
	Part no:	Thread Male	Tube OD
	P68M104	1/4"	10mm
	P68M106	3/8"	10mm
	P68M124	1/4"	12mm
	P68M126	3/8"	12mm
	P68M128	1/2"	12mm
	P68M402	1/8"	4mm
	P68M602	1/8"	6mm
	P68M604	1/4"	6mm
	P68M802	1/8"	8mm
	P68M804	1/4"	8mm

Male Elbow			
	Part no:	Thread Male	Tube OD
	P69M104	1/4"	10mm
	P69M124	1/4"	12mm
	P69M126	3/8"	12mm
	P69M128	1/2"	12mm
	P69M402	1/8"	4mm
	P69M602	1/8"	6mm
	P69M604	1/4"	6mm
	P69M802	1/8"	8mm
	P69M804	1/4"	8mm

Male Run Tee			
	Part no:	Thread Male	Tube OD
	P72M126	3/8"	12mm

Union Bulkhead		
	Part no:	Tube OD
	P74M6	6mm
	P74M8	8mm
	P74M12	12mm

## FITTINGS

### STEEL

Union Bulkhead Elbow		
	Part no:	Tube OD
	BE66	6mm
	BE88	8mm
	BE1010	10mm
	BE1212	12mm

Union Bulkhead		
	Part no:	Tube OD
	BH6	6mm
	BH8	8mm
	BH10	10mm
	BH12	12mm
	BH15	15mm
	BH18	18mm

Bulkhead Connector			
	Part no:	Thread Male	Tube OD
	BH12-1/2	1/2" MPT	12mm
	BHM2210	M22	10mm
	BHM2212	M22	12mm

Cutting Ring		
	Part no:	Tube OD
	CR4	4mm
	CR6	6mm
	CR8	8mm
	CR10	10mm
	CR12	12mm
	CR15	15mm
	CR16	16mm
	CR18	18mm





## FITTINGS

STEEL (CONT...)

Male Elbow Taper			
	Part no:	Thread	Tube OD
	E148	1/4"	8mm
	E186	1/8"	6mm
	E1215	1/2"	15mm
	E1410	1/4"	10mm
	E3812	3/8"	12mm

Union Elbow		
	Part no:	Tube OD
	EE66	6mm
	EE88	8mm
	EE1010	10mm
	EE1212	12mm
	EE1515	15mm
	EE1818	18mm

Male Elbow Metric			
	Part no:	Thread	Tube OD
	EM126	M12	6mm
	EM128	M12	8mm
	EM148	M14	8mm
	EM1210	M12	10mm
	EM1612	M16	12mm
	EM2212	M22	12mm
	EM2215	M22	15mm
	EM2218	M22	18mm

Standpipe Elbow			
	Part no:	Thread Female	Tube OD
	ESV-12M	M18 x 1.5	12mm

Hex Nipple			
	Part no:	Thread Female	Thread Male
	HN2214	1/4"	M22
	HN2212	1/2"	M22
	HN2222	M22	M22
	HN2226	M26	M22

Standpipe Tube Reducer			
	Part no:	Thread	Tube OD
	KOR106L	M10	6mm
	KOR108L	M10	8mm
	KOR128L	M12	8mm

Unions		
	Part no:	Tube OD
	LC9	9mm
	LC11	11mm
	LC44	4mm
	LC66	6mm
	LC88	8mm
	LC1010	10mm
	LC1212	12mm
	LC1515	15mm
	LC1818	18mm

Male Female Adapter			
	Part no:	Thread Male	Thread Female
	MF168	M16	1/2"
	MF422	1/4"	M22
	MF622	3/8"	M22
	MF1622	M16	M22





Tube Nut		
	Part no:	Tube OD
	PN6	6mm
	PN8	8mm
	PN10	10mm
	PN12	12mm
	PN15	15mm
	PN18	18mm

Branch Tee			
	Part no:	Thread Male	Tube OD
	TE12M22	M22	12mm

Hex Plug		
	Part no:	Thread
	P12	M12
	P14	M14
	P16	M16

Union Tee		
	Part no:	Tube OD
	TM6	6 x 6 x 6
	TM8	8 x 8 x 8
	TM10	10 x 10 x 10
	TM12	12 x 12 x 12
	TM15	15 x 15 x 15
	TM18	18 x 18 x 18
	TM868	8 x 6 x 8
	TM10610	10 x 6 x 10
	TM12612	12 x 6 x 12
	TM15615	15 x 6 x 15
	TM151015	15 x 10 x 15

Reducing Bush			
	Part no:	Thread Male	Thread Female
	RB2216	M22	M16
	RB2212	M22	1/2"
	RB22M12	M22	M12

Male Female Elbow			
	Part no:	Thread Male	Thread Female
	SE2222	M22	M22

Tube Insert		
	Part no:	Tube OD
	TS6	6 x 1mm
	TS8	8 x 1mm
	TS10	10 x 1mm
	TS12	12 x 1mm
	TS15	15 x 1mm

Socket			
	Part no:	Thread Male	Thread Female
	S0002	1/4"	1/4"
	S0003	3/8"	3/8"
	S0004	1/2"	1/2"
	S0010	M22	M22
	S0012	M22	1/2"

Standpipe Branch Tee			
	Part no:	Thread Female	Tube OD
	TSB-12M	M18	12mm





## FITTINGS

STEEL (CONT...)

Standpipe Run Tee			
	Part no:	Thread	Tube OD
	<b>TSV-12M</b>	M16	12mm
	<b>TSV-8M</b>	M14	8mm

Male Connector Imperial			
	Part no:	Thread	Tube OD
	<b>U146</b>	1/4"	6mm
	<b>U148</b>	1/4"	8mm
	<b>U186</b>	1/8"	6mm
	<b>U188</b>	1/8"	8mm
	<b>U1212</b>	1/2"	12mm
	<b>U1215</b>	1/2"	15mm
	<b>U1218</b>	1/2"	18mm
	<b>U3810</b>	3/8"	10mm
	<b>U1410</b>	1/4"	10mm
	<b>U1412</b>	1/4"	12mm
	<b>U3415</b>	3/4"	15mm
	<b>U3812</b>	3/8"	12mm
	<b>U3815</b>	3/8"	15mm

Male Connector Metric			
	Part no:	Thread	Tube OD
	<b>UM126</b>	M12	6mm
	<b>UM128</b>	M12	8mm
	<b>UM146</b>	M14	6mm
	<b>UM148</b>	M14	8mm
	<b>UM168</b>	M16	8mm
	<b>UM226</b>	M22	6mm
	<b>UM1210</b>	M12	10mm
	<b>UM1212</b>	M12	12mm
	<b>UM1410</b>	M14	10mm
	<b>UM1610</b>	M16	10mm
	<b>UM1612</b>	M16	12mm
	<b>UM1615</b>	M16	15mm
	<b>UM2210</b>	M22	10mm
	<b>UM2212</b>	M22	12mm
	<b>UM2215</b>	M22	15mm
	<b>UM2218</b>	M22	18mm
	<b>UM2618</b>	M26	18mm

Test Connector Adapter			
	Part no:	Thread	Tube OD
	<b>128-6</b>	1/4"	3/8"
	<b>128-M16</b>	1/4"	M16
	<b>318-066-001</b>	M16	Tube 12mm

Test Connector		
	Part no:	Thread
	<b>PWM2076</b>	1/4"

Test Connector		
	Part no:	Thread
	<b>PWM2078</b>	M18

## FOOT VALVES

Foot Valve	
Part no:	KN22100
	Midland single type
	4 Inlet and 4 outlet ports
	Inlet 1/4" or 1/2", outlet 1/2"
	Repair kit RN10BX

Foot Valve	
Part no:	KN22100
	Midland single type
	4 Inlet and 4 outlet ports
	Inlet 1/4" or 1/2", outlet 1/2"
	Repair kit RN10BX





Foot Valve	
Part no:	KN22150
	Midland dual type
	2 Inlet and 2 outlet ports
	Inlet 3/8", outlet 3/8"
	Repair kit RN10HV
	MV2035

Foot Valve	
Part no:	MV2003
	Dual type
	461-307-479-0
	1 Inlet and 3, outlet ports
	Port size M22

Foot Valve	
Part no:	KN22501
	Midland dual type
	Complete with treadle
	2 Inlet and 2 outlet ports
	Inlet 3/8", outlet 3/8"
	MV2037

Foot Valve	
Part no:	MV2035
	Dual type
	2 Inlet and 2 outlet ports
	Inlet 3/8", outlet 3/8"
	KN22150

Foot Valve	
Part no:	KN22501
	Midland single type
	Complete with treadle
	4 Inlet and 4 outlet ports
	Inlet 1/4 or 1/2", outlet 1/2"
	MV2078

Foot Valve	
Part no:	MV2037
	Dual type
	Complete with treadle
	2 Inlet and 2 outlet ports
	Inlet 3/8", outlet 3/8"
	KN22501

Foot Valve	
Part no:	MV2001
	Dual type
	461-315-008-0
	1 Inlet and 1 outlet ports
	Port size M16

Foot Valve	
Part no:	MV2064
	Dual type
	470-012-000-0
	Mercedes-Benz
	Hydraulic pneumatic
	With slave cylinder

Foot Valve	
Part no:	MV2002
	Dual type
	461-319-018-0
	2 Inlet and 2 outlet ports
	Control port 4
	Port size M16

Foot Valve	
Part no:	MV2078
	Single type
	E2 type
	Complete with treadle
	KN22600





## FOOT VALVES (CONT...)

Exhaust Brake Valve	
Part no:	332-005-001
	Short stem
	Through floor mount
	Inlet M12, outlet M12

Exhaust Brake Valve	
Part no:	332-005-002
	Long stem
	Through floor mount
	Inlet M12, outlet M13

## GAUGES

Simplex	
Part no:	PWM1572A
	Diameter 60mm
	Port size 1/4" male
	Max pressure 100kPa

Simplex	
Part no:	PWM747/A1-400
	Diameter 100mm
	Port size 3/8" male
	Max pressure 400kPa

Simplex	
Part no:	PWM747/A1-1000
	Diameter 100mm
	Port size 3/8" male
	Max pressure 1000kPa

Duplex	
Part no:	PWM747/A2-1000
	Diameter 100mm
	Port size 1/8" male
	Max pressure 1000kPa
	Dual needle

Simplex Vacuum	
Part no:	PWM747/V1-100
	Diameter 100mm
	Port size 3/8" male

Duplex Vacuum	
Part no:	PWM747/V2-100
	Diameter 100mm
	Port size 3/8" male
	Dual needle

## GEARBOX VALVES

Gearbox Control	
Part no:	MV2061
	Mercedes-benz, Iveco, MAN
	571-003-104-0
	4/2 Way
	Control pressure 2bar
	Ports M10 x 1







Directional Control	
Part no:	MV2062
	Mercedes-benz
	ASA5910
	3/2 Way
	Turning knob
	Lock nut and washer
	Ports M10 x 1.5



Range Change	
Part no:	MV2079
	International Freightliner
	KN3546
	Fuller Gearbox
	Push Pull Hi/Low
	Ports 1/8"

Transmission Slave	
Part no:	MV2094
	Fuller Gearbox
	A5000
	5 Port
	Ports 1/8"

## GREASE NIPPLES

Thread	Part No.	Part No.	Part No.	Part No.	Part No.	Part No.
						
	<b>Straight</b>	<b>45°</b>	<b>90°</b>	<b>Button Head</b>	<b>Straight</b>	<b>Push-in</b>
1/8" NPT	GN110	GN111	GN112	+	+	+
1/8" BSP	GN10A	GN11A	GN12A	GN19	+	+
1/4" BSP	GN21	GN22	GN23	GN20	+	+
1/4" UNF	GN13	GN14	GN15	+	GN16	+
5/16" BSF	GN17	GN18	+	+	+	+
5/16" Push in	+	+	+	+	+	GN25
3/8" BSF	+	+	+	GN24	+	+
3/8" BSP	GN41	+	+	+	+	+
6mm x 1m	GN29	GN30	GN31	+	+	+
8mm x 1m	GN35	GN36	GN37	+	+	+
8mm x 1.25m	GN26	GN27	GN28	+	+	+
10mm x 1m	GN38	GN39	GN40	+	+	+
10mm x 1.5m	GN32	GN33	GN34	+	+	+





## GREASE NIPPLES:

### ASSORTMENT

Grease Nipple Assortment	
Part no:	G110
	Imperial

Grease Nipple Assortment	
Part no:	GM110
	Metric

## GREASE NIPPLES:

### HOSES

Grease Hose	
Part no:	1F
	4500psi work pressure
	Single wire braid
	Lenght 10"
	1/8" pipe male thread

Grease Hose	
Part no:	1L
	4500psi work pressure
	Single wire braid
	Lenght 18"
	1/8" pipe male thread

## GREASE NIPPLES:

### COUPLER

Hydraulic Coupler	
Part no:	1K
	Grease gun
	1/8" female pipe thread

## HAND CONTROL VALVES:

### MANOUEVERING VALVES

Manouering Valves	
Part no:	KN20061
	Midland EGP body
	Push to open spring return to close
	Dash mount
	Inlet 1/8", outlet 1/8"

Manouering Valves	
Part no:	3450G
	Sealco metal body
	Push to open spring return to close
	Dash mount
	Inlet 1/8", outlet 1/8"

## HAND CONTROL VALVES:

### TRAILER BRAKE CONTROL

Trailer Brake Control	
Part no:	5900GI
	Sealco
	Rotation type gradual increase in pressure
	Spring return
	Inlet 1/4", outlet 1/4"



Trailer Brake Control	
Part no:	KN20001
	Midland
	Flick switch on/off lock position
	Dash mount
	Inlet 1/8", outlet 1/8"
	MV2031

Trailer Brake Control	
Part no:	KN20561
	Midland
	Gradual increase in pressure
	Lock when released
	Manuel return
	Inlet 1/4", outlet 1/4"
	Steering column mount

Trailer Brake Control	
Part no:	KN20562
	Midland
	Gradual increase in pressure
	No lock position
	Spring return
	Inlet 1/4", outlet 1/4"
	Steering column mount

Trailer Brake Control	
Part no:	MV2031
	Flick switch on/off lock position
	Dash mount
	Inlet 1/8", outlet 1/8"

Trailer Brake Control	
Part no:	MV2050
	TC2 type
	Rotation type gradual increase in pressure
	Dash mount
	Spring return
	Inlet 1/4", outlet 1/4"

## HAND CONTROL VALVES:

### SPRING BRAKE CONTROL

Spring Brake Control	
Part no:	KN20021
	Midland
	Push to release
	Pull to park
	Pops to park below 2.75bar
	Inlet 1/8", outlet 1/8"
	Yellow knob
MV2033	

Spring Brake Control	
Part no:	KN20025
	Midland
	Push to release
	Pull to park
	Pops to park below 2.75bar
	Inlet 1/8", outlet 1/8"
	Red knob
MV2034	

Spring Brake Control	
Part no:	KN20031
	Midland
	Push to release
	Pull to park
	Pops to park below 2.75bar
	Inlet 1/8", outlet 1/8"
	Silver knob
MV2039	

Spring Brake Control	
Part no:	KN20035
	Midland
	Push to release
	Pull to park
	Pops to park below 1.37bar
	Inlet 1/8", outlet 1/8"
	Blue knob
MV2032	



## HAND CONTROL VALVES:

### SPRING BRAKE CONTROL (CONT...)

Spring Brake Control	
Part no:	MV2004
	961-701-110-0
	Rotation type
	Gradual reduction in pressure
	Spring return
	Inlet 1/4", outlet 1/4"
	3 Port

Spring Brake Control	
Part no:	MV2032
	(KN20035)
	Push to release
	Pull to park
	Pops to park below 1.37bar
	Inlet 1/8", outlet 1/8"
	Blue knob

Spring Brake Control	
Part no:	MV2005
	961-703-001-0
	Rotation type
	Gradual reduction in pressure
	Spring return
	Inlet 1/4", outlet 1/4"
	2 Delivery ports, 1 supply port
4 Port	

Spring Brake Control	
Part no:	MV2033
	(KN20021)
	Push to release
	Pull to park
	Pops to park below 2.75bar
	Inlet 1/8", outlet 1/8"
	Yellow knob

Spring Brake Control	
Part no:	MV2023
	961-722-252-0
	Rotation type
	Gradual reduction in pressure
	Spring return
	Inlet 1/4", outlet 1/4"
	2 Delivery ports, 1 supply port

Spring Brake Control	
Part no:	MV2034
	(KN20025)
	Push to release
	Pull to park
	Pops to park below 2.75bar
	Inlet 1/8", outlet 1/8"
	Red knob

Spring Brake Control	
Part no:	MV2024
	DAF, Iveco, Scania, Volvo
	961-721-004-0
	Pull type spring return
	Two port side M14 x M1.5
	Input pressure 15bar
	Output pressure 7.5bar
Centre bracket lock position	

Spring Brake Control	
Part no:	MV2039
	(KN20031)
	Push to release
	Pull to park
	Pops to park below 2.75bar
	Inlet 1/8", outlet 1/8"
	Silver knob





Spring Brake Control	
Part no:	MV2065
	Scania, MAN
	961-723-122-0
	3 Port side voss
	With test position
	Stroke 73
	Port size M16 x 1.5

Spring Brake Control	
Part no:	MV2069
	Mercedes-Benz
	961-721-040-0
	2 Port spring return
	Input pressure 8.5bar
	Output pressure 7.5bar
	Port size M14 x 1.5

Spring Brake Control	
Part no:	MV2066
	Mercedes-Benz Actros
	961-723-125-0
	3 Port side voss
	With test and lock position
	Stroke 73
	Port size M16 x 1.5

Spring Brake Control	
Part no:	MV2070
	Mercedes-Benz, DAF
	961-722-252-0
	3 Port left hand side bracket
	Stroke 73
	Test position
	Port size M14 x 1.5

Spring Brake Control	
Part no:	MV2067
	MAN
	961-723-118-0
	3 Port side voss
	With test and lock position
	Stroke 73
	Port size M16 x 1.5

Spring Brake Control	
Part no:	MV2071
	Mercedes-Benz
	961-722-284-0
	4 Port side
	Centre bracket
	Without test position
	Port size M14 x 1.5
Stroke 73	

Spring Brake Control	
Part no:	MV2068
	Mercedes-Benz
	961-721-000-0
	2 Port side
	Input pressure 8.5bar
	Output pressure 7.5bar
	Stroke 90
	Port size M14 x 1.5

Spring Brake Control	
Part no:	MV2072
	Mercedes-Benz
	961-722-264-0
	4 Port
	Side bracket
	Without test position
	Port size M14 x 1.5
	Stroke 73



## HAND CONTROL VALVES:

### SPRING BRAKE CONTROL (CONT...)

Spring Brake Control	
Part no:	MV2073
	Mercedes-Benz
	961-723-104-0
	3 Port side
	Centre bracket
	With test position
	Port size M14 x 1.5
	Stroke 73 with park position

Spring Brake Control	
Part no:	S99600B
	Sealco
	Pull to release
	Push to park
	Pops to park below 2bar
	Inlet 1/4", outlet 1/4"

Spring Brake Control	
Part no:	17600B
	Sealco
	Push to release
	Pull to park
	Pops to park below 2.75bar
	Supply port 1/8"
	Control port 1/8"
	Delivery port 1/4"

## HYDRAULIC BRAKE MASTER CYLINDER

Master Cylinder Tandem	
Part no:	H17853.1.1
	Mercedes-Benz
	3182950006
	Casting S5207
	Kit major RK1787

Master Cylinder Tandem	
Part no:	H19715.9.0
	Volkswagen Beetle
	113.611.021C
	Casting S19
	Kit major RK1953

Master Cylinder Tandem	
Part no:	H25794
	Mercedes-Benz
	000-430-640-1
	Casting S134
	Kit major RK2553

Master Cylinder Tandem	
Part no:	H31720.0.0
	Iveco
	2620411
	Casting S415
	Kit major 31540

Master Cylinder Tandem	
Part no:	H31732.0.1
	Iveco
	2468158
	Casting S367
	Kit major rk31520
	Kit minor rk3179



Master Cylinder Tandem	
Part no:	H33902.0.1
	Mercedes-Benz
	003-430-130-1
	Casting S33

Master Cylinder Tandem	
Part no:	H34703.0.0
	Daimler
	002-430-410-1
	Casting S406
	Kit major RK3450

Master Cylinder Tandem	
Part no:	H38933.0.8
	Mercedes-Benz
	002-430-820-1
	Casting S5019
	Kit major RK38542

Master Cylinder Tandem	
Part no:	H38944.0.2
	Mercedes-Benz
	003-430-300-1
	Casting S5154
	Kit major RK3892

Master Cylinder Tandem	
Part no:	H42900.0.1
	Mercedes-Benz
	003-430-320-1
	Casting S5179
	Kit major RK4251

## HYDRAULIC CLUTCH:

### MASTER CYLINDER

Clutch Master Cylinder	
Part no:	KG19046.1.2
	Mercedes-Benz
	000-295-770-6
	Casting S5091
	Kit minor RK19547

Clutch Master Cylinder	
Part no:	KG23021.1.2
	Mercedes-Benz 2517
	000-810-059-8
	Casting S5372
	Kit minor RK23718

Clutch Master Cylinder	
Part no:	KG23027.0.1
	MAN
	81-307-156-111
	Casting S5536K
	Kit major RK23722

Clutch Master Cylinder	
Part no:	KG2-3401.0.1
	Iveco/MAN
	81-307-156-037
	Casting S5307
	Kit minor RK34502

Clutch Master Cylinder	
Part no:	KG23712.1.4
	MAN
	81-307-156-065
	Casting S5294
	Kit major RK23720



## HYDRAULIC CLUTCH:

### MASTER CYLINDER (CONT...)

Clutch Master Cylinder	
Part no:	KG23791.1.2
	MAN
	81-307-156-011
	Casting S5570
	Kit minor RK2381

Clutch Master Cylinder	
Part no:	KG23799.1.1
	MAN
	81-307-156-049
	Casting S5248
	Kit major RK2388

Clutch Master Cylinder	
Part no:	KG2394.1.12
	Iveco/DAF
	2479001
	Casting S5138
	Kit major RK23732

Clutch Master Cylinder	
Part no:	KG2395.1.3
	Mercedes-Benz
	Casting S5185K
	Kit major RK23714
	Kit minor RK23513

Clutch Master Cylinder	
Part no:	KG2395.1.7
	Mercedes-Benz
	00-295-68-06
	Casting S5138
	Kit major RK23714

Clutch Master Cylinder	
Part no:	KG2397.1.6
	Renault
	281-100-100-210
	Casting S5199K
	Kit major RK23732

Clutch Master Cylinder	
Part no:	KG25794.1.3
	MAN
	81307-156-066
	Casting S6066
	Kit major RK25714

Clutch Master Cylinder	
Part no:	KG2602.1.1
	Mercedes-Benz
	001-295-08-06
	Casting S5373
	Kit minor RK26504

Clutch Master Cylinder	
Part no:	KG2604.1.1
	Mercedes-Benz
	001-295-30-06
	Casting S5373
	Kit minor RK26504

Clutch Master Cylinder	
Part no:	KG2605.1.1
	Mercedes-Benz
	001-295-64-06
	Casting S5477
	Kit major RK26700

Clutch Master Cylinder	
Part no:	KG28706.1.1
	MAN
	81-307-156-084
	Casting S5424
	Kit major RK28700

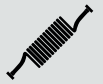



## HYDRAULIC CLUTCH:

### SLAVE CYLINDER

Clutch Slave Cylinder	
Part no:	KN25042A1
	Mercedes-Benz
	001-295-43-07
	Casting S6430
	Seal H25310

Clutch Slave Cylinder	
Part no:	KN25021D1
	Fiat, Iveco
	002-295-15-07
	Casting S6167
	Kit minor RK25078

Clutch Slave Cylinder	
Part no:	KN28013A1
	MAN
	81-307-166-020
	Casting S6271
	Kit minor RK28018

Clutch Slave Cylinder	
Part no:	KN28014C1
	MAN
	81-307-166-055
	Casting S6369
	Kit major RK28814K

Clutch Slave Cylinder	
Part no:	KN28020D1
	Mercedes-Benz
	001-295-20-07
	Casting S6430
	Kit major RK28013K

Clutch Slave Cylinder	
Part no:	KN28024E1
	Mercedes-Benz
	Casting S6501

Clutch Slave Cylinder	
Part no:	KN2895A1
	Mercedes-Benz
	000-295-83-07
	Casting S6205K
	Kit minor RK28021

Clutch Slave Cylinder	
Part no:	KN3406E77
	Magirus Deutz/Iveco
	5177-52-25-50
	Casting S6173
	Kit minor RK3429

Clutch Slave Cylinder	
Part no:	KN3805J1
	Mercedes-Benz
	001-295-03-07
	Casting S6197K
	Kit major RK38816K
	Kit minor RK3848

Clutch Slave Cylinder	
Part no:	KN3890A1
	Iveco
	4459140
	Casting S6292
	Kit minor RK3846

Clutch Slave Cylinder	
Part no:	KN3895B1
	Mercedes-Benz
	001-295-10-07
	Casting S6405
	Kit major RK38816K





## HYDRAULIC CLUTCH:

### SLAVE CYLINDER (CONT...)

Clutch Slave Cylinder	
Part no:	N24802C1
	Mercedes-Benz
	000-296-01-07
	Casting S6284
	Kit major RK2413

Clutch Slave Cylinder	
Part no:	N24803C1
	Mercedes-Benz
	004-420-55-18
	Casting S6284
	Kit minor RK2413

## HYDRAULIC WHEEL CYLINDER

Wheel Cylinder	
Part no:	R22036A1
	Daimler
	395-34-0820
	Casting S6008K
	Kit major RK22069K

Wheel Cylinder	
Part no:	R3102A1
	MAN
	90-810-845-631
	Casting S54
	Kit major RK31038K

Wheel Cylinder	
Part no:	R3898B1
	Mercedes-Benz
	90-810-845-631
	Casting S6046
	Kit major RK3835K

Wheel Cylinder	
Part no:	R4101A30
	MAN
	81504-056-085
	Casting S6511
	Kit minor RK4149

Wheel Cylinder	
Part no:	R4192B1
	Mercedes-Benz
	003-420-77-18
	Casting S6102
	Kit minor RK4114
	Kit major RK4149K

Wheel Cylinder	
Part no:	R44024A1
	Mercedes-Benz
	009-420-15-18
	Casting S6508
	Kit major RK44042K

Wheel Cylinder	
Part no:	R4601A1
	Mercedes-Benz
	001-420-46-18
	Casting S680
	Kit major RK4611K

Wheel Cylinder	
Part no:	R4604D1
	Mercedes-Benz
	002-420-20-18
	Casting S6044
	Kit major RK4611K





Wheel Cylinder	
Part no:	R50016A1
	Mercedes-Benz
	009-420-16-18
	Casting S6243K
	Kit major RK5024

Wheel Cylinder	
Part no:	R5091C1
	Mercedes-Benz
	000-420-71-18
	Casting S6045
	Kit major RK5024K

Wheel Cylinder	
Part no:	R5098A1
	Mercedes-Benz
	003-420-98-18
	Casting S6243
	Kit major RK5024K

## HYDRAULIC WHEEL CYLINDER: FLUID RESERVOIR

Brake Fluid Reservoir	
Part no:	A8000
	Brake Fluid Reservoir

Brake Fluid Reservoir	
Part no:	A8029
	Brake Fluid Reservoir

## LOAD SENSING VALVES

Load Sensing Linkage	
Part no:	ASA5081A
	Axle rubber linkage

Load Sensing	
Part no:	MV2026
	Spring suspension
	475-701-020-0
	No in shot
	Ports M22

Relay Load Sensing	
Part no:	MV2087
	MAN F2000
	475-710-016-0
	Port 1 and 2, M22
	Port 4 M16
	Control angle 60°

Buffer Kit	
Part no:	PWM1220/BK/2
	No rods
	No linkages

Cable and Spring	
Part no:	03-0386-09
	Grau load sensing
	Fits 601-013-011

Spring Box	
Part no:	433-302-002-0
	Spring Box



## LOAD SENSING VALVES (CONT...)

Load Sensing Linkage	
Part no:	475-701-712-2
	Arm and rubber

Relay Load Sensing	
Part no:	475-710-036-0
	Wabco General Truck Trailer
	Without arm
	Inlet M16/M22
	Outlet M22

Relay Load Sensing	
Part no:	475-711-024-0
	Air suspension Wabco, Mercedes-Benz
	Control pressure 0.6-4.3bar
	Inlet M16/M22
	Outlet M22

Load Sensing	
Part no:	475-714-510-0
	Air suspension Wabco
	Control pressure 0.4-3.6bar
	No relay function
	Port 1 and 2, M22
	Port 4 and 41, M16

Load Sensing	
Part no:	601-013-011
	Static spring suspension
	Grau
	Ports M16
	Cable and spring

Relay Load Sensing	
Part no:	61-30-020-0
	Spring suspension
	475-710-036-0
	With arm
	Inlet M16/M22
	Outlet M22

## PRESSURE SWITCHES

D Type Compressor	
Part no:	PWM3365/1
	FHG-12 2 pole
	Cut out range 485-1035kPa
	Differential 205kPa
	Thread 1/4" x 6mm

D Type Compressor	
Part no:	PWM3365/B
	FHG-2
	Cut out range 275-690kPa
	Differential 140kPa
	Thread 1/4" x 6mm

Vacuum	
Part no:	T369A/B
	Closes with drop in vacuum
	Port 1/4" mate

Low Pressure	
Part no:	13241A
	Midland type
	Closes below 4.5bar
	Port size 1/4" mate



Stop Light	
Part no:	13250
	Midland type
	Closes above 0.2bar
	Port size 1/4" mate

Protection Valve	
Part no:	MV2007
	434-100-125-0
	With reverse flow
	Opening pressure 450kPa
	Port size M22 female

Stop Light	
Part no:	361-006-201
	Grau
	Closes above 0.5bar
	Port size M12 mate

Protection Valve	
Part no:	MV2008
	434-100-104-0
	No reverse flow
	Opening pressure 550kPa
	Port size M22 female

## PROTECTION VALVES: ADJUSTABLE PROTECTION VALVES

Protection Valve	
Part no:	KN31000
	Midland
	Limited reverse flow 310kPa
	Opening pressure 450kPa
	Port size 1/4" female

Protection Valve	
Part no:	1300
	Sealco
	Adjustable 20-70psi
	Opening pressure 4bar
	Port size 1/4" female
	Nominal closing 60psi

Protection Valve	
Part no:	MV2006
	434-100-124-0
	No reverse flow
	Opening pressure 450kPa
	Port size M22 female

Protection Valve	
Part no:	434-100-122-0
	Wabco
	No reverse flow
	Opening pressure 450kPa
	Port size M22





## PROTECTION VALVES: FOUR CIRCUIT PROTECTION VALVES

Protection Valve	
Part no:	MV2010
	7 Port 4 circuit
	934-702-221-0
	Inlet port M22
	Outlet port M16
	20bar

Protection Valve	
Part no:	MV2018
	7 Port 4 circuit
	934-702-210-0
	Inlet port M22
	Outlet port M16
	10bar

Protection Valve	
Part no:	MV2019
	7 Port
	934-702-221-0
	Inlet port M22
	Outlet port M16
	8.5bar

Protection Valve	
Part no:	MV2020
	5 Port 4 circuit
	934-702-320-0
	Inlet port M22
	Outlet port M16
	20bar

Protection Valve	
Part no:	MV2021
	5 Port 4 circuit
	934-702-300-0
	Inlet port M22
	Outlet port M16
	20bar

Protection Valve	
Part no:	MV2043
	5 Port 4 circuit
	934-702-250-0
	Inlet port M22
	Outlet port M16
	20bar

Protection Valve	
Part no:	MV2074
	6 Way
	934-705-005-0
	Inlet port M22
	Outlet port M22
	8.5bar



## PROTECTION VALVES:

### TRACTOR PROTECTION VALVES

Tractor Protection	
Part no:	KN34050
	Midland
	3 Line with quick release
	Emergency port 3/8"
	Service port 1/2"
	Trailer emergency port 1/2"
	Trailer service port 1/2"

Tractor Protection	
Part no:	KN34060
	Midland
	2 Line with quick release
	Emergency port 3/8"
	Service port 1/2"
	Trailer emergency port 1/2"
	Trailer service port 1/2"

## QUICK RELEASE VALVES

Limiting and Quick Release	
Part no:	MV2088
	LQ 2 Type
	Ports 1/2", 1/4"
	229507

Quick Release	
Part no:	1602100
	Delivery port 1, 3/8"
	Inlet port 1/2"
	Delivery port 2, 3/8"
	Repair kit 229813
	Repair kit 229813L large seal

Quick Release	
Part no:	356-006-011
	Delivery port 1, M22
	Inlet port M22
	Delivery port 2, M22
	Repair kit 229813
	Repair kit 229813L large seal

Quick Release Wabco	
Part no:	973-500-000-0
	Delivery port 1, M22
	Inlet port M22
	Delivery port 2, M22
	Repair kit 229813
	Repair kit 229813L large seal

## QUICK RELEASE VALVES:

### REACTION VALVES

Vacuum over Hydraulic	
Part no:	MAG2733-001-00
	Twin line inverted
	Dual hydraulic circuit



## QUICK RELEASE VALVES:

### REPAIR KITS

Repair Kit for 1602100	
Part no:	229813
	Standard seal

Repair Kit	
Part no:	229813L
	Large seal

## QUICK RELEASE VALVES:

### ADAPTOR KNICK VALVE

Knick Valve	
Part no:	356-005-102
	DAF/Iveco, MAN, Mercedes-Benz
	Pressure range 0.6-0.8bar
	Port M22

## REGULATORS

Regulators	
Part no:	R 4
	Gauge 1/8"BSP port
	Pressure range 0-11bar
	Thread 1/4" female

Regulators	
Part no:	R 8
	Gauge 1/4"BSP port
	Pressure range 0-11bar
	Thread 1/2" female

Regulators	
Part no:	21241
	Gauge 1/8"BSP port
	Pressure range 0-11bar
	Thread 1/2" female

## RELAY VALVES

Relay Valve	
Part no:	KN28060
	Midland 2 delivery ports
	Supply port 1/2"
	Delivery port 3/8"
	Control port 3/8"
	Repair kit rN10hk

Relay Valve	
Part no:	MV2011
	Square relay
	Supply port M22
	Delivery port M22
	Control port M22





Relay Valve	
Part no:	MV2012
	Square relay
	Supply port M16
	Delivery port M22
	Control port M16

Relay Valve	
Part no:	11900
	Air starter Sealco
	Supply port 1 and 1/2"
	Delivery port 1 and 1/2"
	Control port 1/4"

Relay Valve	
Part no:	MV2084
	Square relay
	973-011-001-0
	Park brake
	Thread voss
	Port 1 and 2 M22
	Port 4 M16

Relay Valve	
Part no:	280375
	Standard R6
	Supply port 1/2"
	Delivery port 3/8"
	Control port 1/4"
	Repair kit 280856/M

Relay Valve	
Part no:	6900
	Air starter Sealco
	Supply port 1"
	Delivery port 1"
	Control port 1/4"
	Repair kit 6900-5

Relay Valve	
Part no:	973-001-010-0
	Wabco square relay
	Supply port M22
	Delivery port M22
	Control port M22

Relay Valve	
Part no:	9125
	Sealco
	Supply port 1/2"
	Delivery port 3/8"
	Control port 1/4"







## RELAY VALVES:

### RELAY EMERGENCY VALVES

Emergency Relay	
Part no:	KN30400
	Midland
	Supply port 1/4"
	Delivery port 3/8"
	Service port 1/4"
	Reservoir port 3/4"
	Repair kit RN10HL

Emergency Relay	
Part no:	MV2082
	Ports M22
	971-002-150-0
	With Adjustable Predominance
	Ratio Version
	Maximum Operating Pressure 10bar

Emergency Relay	
Part no:	MV2083
	Ports M22 Port 4 M16
	971-002-300-0
	Without Predominance
	With dump
	Maximum Operating Pressure: 8.5bar

Emergency Relay	
Part no:	110139
	Sealco with advance
	Supply port 3/8"
	Delivery port 3/8"
	Service port 3/8"
	Reservoir port 3/4"

Emergency Relay	
Part no:	281864
	Standard re6
	Supply port 1/4"
	Delivery port 3/8"
	Service port 1/4"
	Reservoir port 3/4"

Emergency Relay	
Part no:	110205A
	Sealco with advance
	Supply port 1/4"
	Delivery port 3/8"
	Service port 1/4"
	Reservoir port 3/4"



## RELAY VALVES:

### VACUUM RELAY VALVES

Relay Vacuum	
Part no:	PV48A
	Inverted non standard
	Upright
	Supply port 1/2"
	Delivery port 3/4"
	Service port 1/8"
	Reservoir port 1"

Relay Vacuum	
Part no:	PV48V
	Inverted standard
	Upright
	Supply port 1/2"
	Delivery port 3/4"
	Service port 1/8"
	Reservoir port 1"

## SAFETY VALVES

Relief Valve	
Part no:	KN31200
	Reservoir mounted
	Cut out pressure 10bar
	Port size male 1/4"

Relief Valve	
Part no:	MC820238
	Japanese
	Port size male 1/4" JIS

Relief Valve	
Part no:	WM342B
	Williams control
	Reservoir mounted
	Adjustable
	Cut out pressure 10bar

## SLACK ADJUSTERS:

### AUTOMATIC SLACK ADJUSTERS

Automatic Slack	
Part no:	14151
	37 Spline universal trailer
	Lever length 127mm/152mm
	Pin hole 14mm

## SLACK ADJUSTERS:

### MANUAL SLACK ADJUSTERS

Straight	
Part no:	N21155PC
	37 Spline
	Lever length: 102mm/127mm/152mm
	Pin hole 12.7mm

Straight	
Part no:	2010
	10 Spline
	Lever length: 127mm/152mm/178mm
	Pin hole 12.7mm



## SLACK ADJUSTERS:

### MANUAL SLACK ADJUSTERS (CONT...)

Straight	
Part no:	2021
	28 Spline rockwell
	Lever length 140mm/165mm
	Pin hole 12.7mm

Straight	
Part no:	2057
	27 x 27 square
	Lever length 127mm/152mm
	Pin hole 12.7mm

## SOLENOID VALVES

Solenoid Valve	
Part no:	SAS-302
	2-3 Way 24V
	Inlet supply 1/4 jis
	Outlet supply 1/4 jis

## SPRING BRAKES:

### DIAPHRAGMS

Diaphragm	
Part no:	234099
	Type 20

Diaphragm	
Part no:	234100
	Type 24

Diaphragm	
Part no:	234101
	Type 30

Diaphragm	
Part no:	234189
	Type 16

Diaphragm	
Part no:	234226
	Type 12





Diaphragm	
Part no:	234362
	Type 36

Diaphragm	
Part no:	234100LS
	Type 24
	Long stroke

Diaphragm	
Part no:	234101LS
	Type 30
	Long stroke

## SPRING BRAKES: DOUBLE DIAPHRAGMS

Spring Brake	
Part no:	16/24-2000
	Type 16 service
	Type 24 spring
	Stroke length 57mm
	Port size 3/8 female
	Clevis pin diameter 12.7mm

Spring Brake	
Part no:	2024COMB
	Type 20 service
	Type 24 spring
	Stroke length 57mm
	Port size 3/8 female
	Clevis pin diameter 12.7mm

Spring Brake	
Part no:	2424COMB
	Type 24 service
	Type 24 spring
	Stroke length 57mm
	Port size 3/8 female
	Clevis pin diameter 12.7mm

Spring Brake	
Part no:	2430COMB-64MM
	Type 24 service
	Type 30 spring
	Stroke length 64mm
	Port size 3/8 female
	Clevis pin diameter 12.7mm

Spring Brake	
Part no:	3030COMB
	Type 30 service
	Type 30 spring
	Stroke length 66mm
	Port size 3/8 female
	Clevis pin diameter 15.8mm

Spring Brake	
Part no:	3636COMB
	Type 36 service
	Type 36 spring
	Stroke length 75mm
	Port size 3/8 female
	Clevis pin diameter 12.7mm

Spring Brake	
Part no:	9/16-2000
	Type 9 service
	Type 16 spring
	Stroke length 45mm
	Port size 3/8 female
	Clevis pin diameter 12.7mm





## SPRING BRAKES:

### PISTON DIAPHRAGMS

Spring Brake	
Part no:	KSC50HBBC175NN
	Type 50 service
	Type 50 spring
	Front 50 service
	Port size 3/8

Spring Brake	
Part no:	KSM2460GC800YN
	Type 24 service
	Type 60 spring
	Rear 24 service
	Port size 3/8
	Clevis pin diameter 12.4mm

Spring Brake	
Part no:	KSM3060GC800YN
	Type 30 service
	Type 60 spring
	Rear 30 service
	Port size 3/8
	Clevis pin diameter 12.4mm

Spring Brake	
Part no:	16/24PD
	Type 16 service
	Type 24 spring
	Stroke length 57mm
	Port size M16
	Clevis pin diameter 12.7mm

Spring Brake	
Part no:	24/24PD
	Type 24 service
	Type 24 spring
	Stroke length 57mm
	Port size M16
	Clevis pin diameter 13mm

Spring Brake	
Part no:	30/30PD
	Type 30 service
	Type 30 spring
	Stroke length 66mm
	Port size M16
	Clevis pin diameter 14mm

## SPRING BRAKES:

### PISTON

Spring Brake	
Part no:	565
	Bz type
	Long stroke
	125mm diameter service
	Port size M16

## SPRING BRAKES:

### REPAIR KITS

Repair Kit	
Part no:	9030001
	2430 Spring brake
	Seal and guide kit



## TRAILER CONTROL VALVES

Trailer Control	
Part no:	MV2013
	Automatic dump
	973-002-520-0
	Predominance none
	Port size M16

Trailer Control	
Part no:	MV2014
	Automatic dump
	973-002-521-0
	Predominance 0.2bar adjustable
	Port size M16

Trailer Control	
Part no:	MV2015
	Mercedes-Benz, Iveco, MAN
	973-002-000-0
	No automatic dump
	Predominance 0.6bar
	Port size M22

Trailer Control	
Part no:	MV2075
	Mercedes-Benz, MAN, Powerliner
	973-009-001-0
	Automatic dump
	Predominance 0.3bar adjustable
	Port size M22

## UNLOADER VALVES

Unloader Valve	
Part no:	MV2016
	No check valve
	975-303-474-0
	Extra port for air dryer 4 port
	Tyre inflater
	Cut out pressure 8.1bar
	Port size M22 female

Unloader Valve	
Part no:	MV2017
	With check valve
	979-303-473-0
	Extra port for air dryer 2 port
	Tyre inflater
	Cut out pressure 8.1bar
	Port size M22 female

## UNLOADER VALVES:

### GOVERNOR VALVES

Governor Valve	
Part no:	MV2038
	D2 Type
	Ports 1/8"
	Cut in pressure 85psi
	Cut out pressure 110psi

Governor Valve	
Part no:	KN18530
	Midland D2
	Ports 1/8"
	Cut in pressure 85psi
	Cut out pressure 110psi



## UNLOADER VALVES:

### GOVERNOR VALVES (CONT...)

Governor Valve	
Part no:	MC802149
	Japanese
	Inlet Port 1/2" Male
	Outlet Port 1/2" Male
	8.5-7.6bar

## WILLIAMS CONTROLS:

### THROTTLE CONTROL VALVES

Throttle Control	
Part no:	WM453M
	Air type
	One inlet
	One outlet
	Through floor mount
	With treadle
	Port size 1/4" NPTF
	Repair kit 119279

## WILLIAMS CONTROLS:

### AIR/HYDRAULIC REACTION VALVE

Reaction Valves	
Part no:	WM388-105
	Air type
	One inlet
	Supply pressure 150psi
	Port size 1/4" NPTF

Throttle Control	
Part no:	WM511C
	Hydraulic type
	One inlet
	One outlet
	Through floor mount
	With treadle
	Port size 1/4" NPTF
	Repair kit 119305

Reaction Valves	
Part no:	WM388UICID
	Air type
	One inlet
	Supply pressure 150psi
	Port size 1/4" NPTF

Throttle Control	
Part no:	WM515C
	Hydraulic type
	One inlet
	One outlet
	Through floor mount
	With treadle
	Port size 1/4" NPTF
	Repair kit 119305

Reaction Valves	
Part no:	WM512C
	Hydraulic type
	Low pressure one inlet
	Port sae6 straight
	Repair kit W19280

Throttle Control	
Part no:	WM90-DX
	Air type
	One inlet
	One outlet
	Through floor mount
	No treadle
	Port size 1/4" NPTF
	Repair kit 117103



TW in line air brake kit  
tandem semi mechanical suspension  
ABS 24V 4S2M (4 sensors - 2 modules)

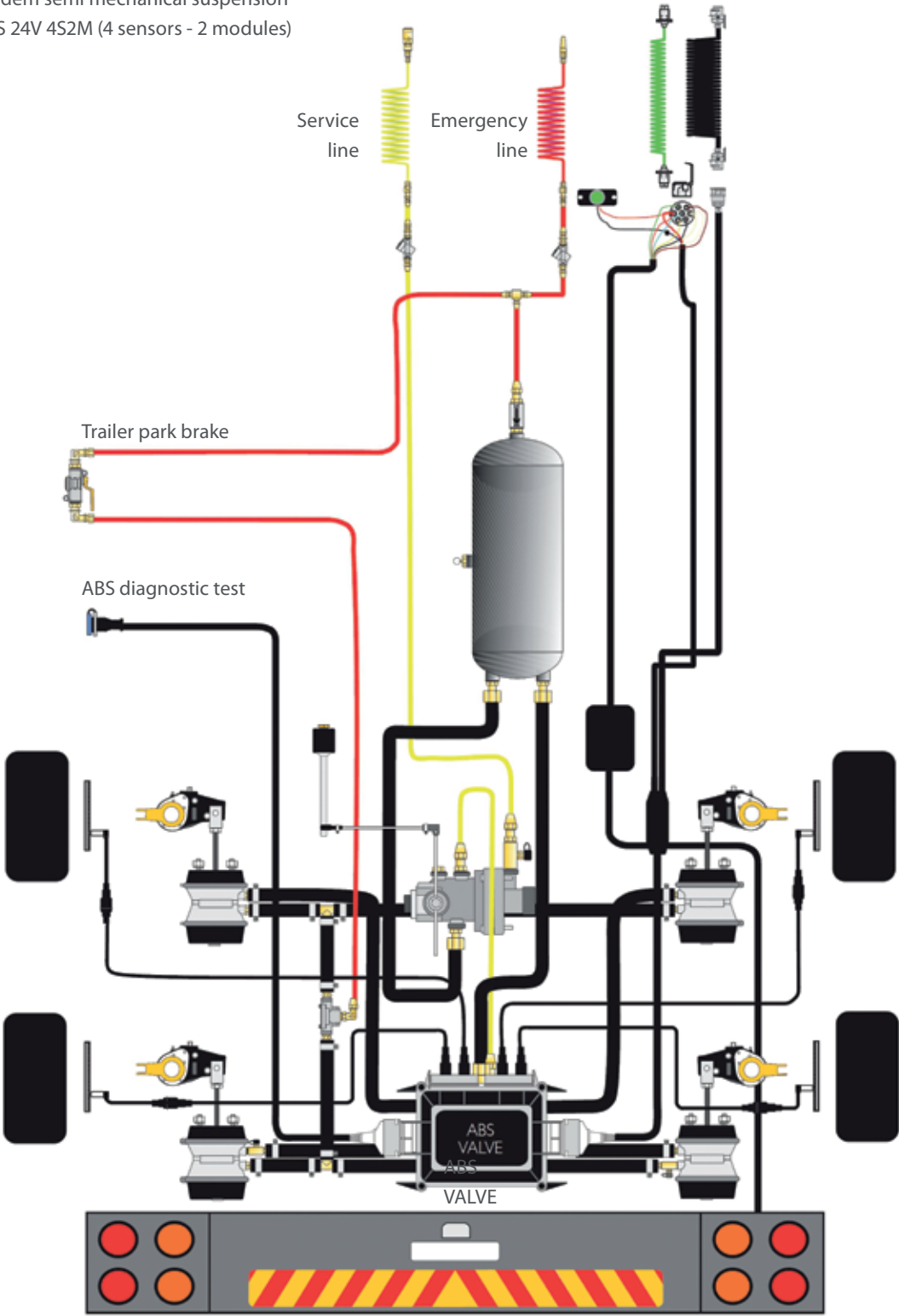



# TERMS & CONDITIONS

## WARRANTY POLICY

1. This warranty is expressed in lieu of all other warranties and representations express or implied.
2. Torre Automotive PTY Ltd warrants that all Airbrake and Industrial products supplied to its customers comply with the relevant industry quality standards.
3. Torre Automotive warrants all Airbrake and Industrial products for a minimum period of 12 months from date of purchase subject to specific restrictions and or warranty limitations which are detailed below.
4. The Torre Automotive warranty covers all manufacturing defects, but does not cover normal deterioration of a product through normal use. Torre Automotive warrants that the products manufactured and or distributed shall be free from defects in material and workmanship.
5. Any product, in respect of which a manufacturing defect has been found, may be returned to Torre Automotive within its warranty period in order for it to be repaired or replaced or to have the purchase price of the product repaid, at Torre Automotive's discretion. The replacement unit will be similarly warranted but only for the balance of the duration of the original warranty.

## CONSUMER PROTECTION ACT WARRANTIES

6. In terms of the Consumer Protection Act No. 68 of 2008 (CPA), in the event that a product supplied by Torre Automotive is unsuitable for its intended purpose, of poor quality, not in good working order, defective, sub-standard or wears out before the reasonable service life of the product and the product is returned to Torre Automotive within six months after delivery of the product to the buyer, Torre Automotive will:
  - a. Repair the product;
  - b. Replace the product; or
  - c. Refund the price of the product.
7. In terms of the CPA, if Torre Automotive is directed to repair the product and, within 3 months after that repair, that repair is ineffective or a further problem with the product is discovered, Torre Automotive will then replace the product or refund the price of the product.
8. Torre Automotive will have the right not to provide the remedies set out above to the extent that the CPA does not oblige Torre Automotive to do so in the circumstances of a particular case.

## GENERAL CONDITIONS, RESTRICTIONS & LIMITATIONS

9. The buyer of the product must make use of Torre Automotive's returns policy and claims procedure, available on its website [www.torreautomotive.co.za](http://www.torreautomotive.co.za), or available directly from the company or any of its representatives. Except to the extent impermissible in terms of the CPA, no warranty claims will be approved by Torre Automotive unless these returns policy and claims procedures are followed.
10. Notwithstanding the returns policy but subject to the CPA, Torre Automotive reserves the right to at any stage reject the return of goods should it feel that the goods have been abused or that the goods have deteriorated through excessive use within the warranty period. Torre Automotive shall then have the option to return the rejected goods to the buyer.
11. Torre Automotive shall not be liable for damages resulting from delays in shipment or inability to ship due to normal production and shipment delays or those resulting from acts of God, fires, floods, wars, sabotage, accidents, labour disputes or shortages, plant shutdown or equipment failure, voluntary or involuntary compliances with any law, order, rule or regulation of governmental agency or authority; or inability to obtain material (including power and fuel), equipment or transportation, or arising from any other contingency, circumstances or event beyond the control of Torre Automotive.
12. All Torre Automotive products are fit for the purpose for which they have been supplied. In the case of products listed in this catalogue, products should only be used in the vehicles described and under the operating conditions appropriate to these vehicles. The warranty applies only to goods where the user can prove that such goods became defective in normal and proper use.
13. Except to the extent permissible in terms of the CPA, Torre Automotive will not be liable for any loss of profit or any consequential loss or damage, from whatever cause arising, including loss of any labour or fitment costs.
14. The above warranty only applies within the warranty period, and when proof of purchase can be verified. A copy of the customer's original purchase invoice is required for all warranty claims. The customer's details should be provided with the claim.



## Core Brands of TAS Parts and Components

---

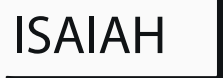

## HEAD OFFICE

JOHANNESBURRANDBURG

TIME ACCESS AND AUTOMOTIVE SYSTEMS

23 STEVENS ROAD, BLAIRGOWRIE, RANDBURG

South Africa

Tel: +27(0)11 326 4146

Cell +27(0)82 375 3280

Fax: +27(0)11 781 4392

[adriang@lantic.net](mailto:adriang@lantic.net)

[www.t-a-s.co.za](http://www.t-a-s.co.za)

[www.timeandautomotive.co.za](http://www.timeandautomotive.co.za)

